

INON

X-2 R5

User Manual



Thank you for purchasing INON housing.

The INON X-2 for R5 is underwater camera housing for Canon EOS R5. Please make sure to read and understand this manual and camera's user manual before you use.

Precautions

- This product is designed and manufactured for use in severe conditions and all housings have been pressure tested in water and fully checked for proper function before shipping. However it is essential to receive **pre dive check and post dive maintenance by a user, and periodic overhaul at INON** to ensure your X-2 housing maintains optimum performance including factory default water-proof property. Please carefully read through this manual to familiar with functions, characteristics, proper usage and maintenance procedures before you use this product.
- Please note that levers/buttons of the housing may scratch housed camera/lens.
- INON Inc. cannot indemnify anyone for any direct/indirect loss/damage on camera/lens caused by malfunction/flooding of this product.
- It is recommended to insure your equipment including the housing, camera, lens etc. by travel insurance or accident insurance with personal effect coverage in case accident (damage, theft etc.) should happen.
- Should you have trouble like flooding or malfunction, INON Inc. shall not be liable for incidental damage (relevant expense to take a shot or lost earnings etc.).
- Impact shock on the housing may cause damage/malfunction of housed camera/lens. ***DO NOT*** transport camera/lens housed in the housing except for carrying equipment to a dive site just before diving.
- Please be advised that some of images in this manual may be different from actual product specification (color etc.) for the illustrative purpose.

Contents

Precautions.....	1
Contents	2
Measures to Prevent Accidental Flooding.....	3
O-ring Inspection Locations	3
O-ring Inspection	3
O-ring Maintenance	4
Installing, Removing, Replacing O-ring.....	5
Checking Main O-ring Condition	6
Names of Parts.....	7-9
Usage	10
Opening the Housing	10
Closing the Housing.....	10
Quick Shoe Main Base	11
Adjusting D5 Holder	12
Installing Port/EXT. Ring	13
Load Battery	13
Setting a Camera	14
Leak Sensor.....	15-18
Connecting Optical Cable	19
Using a Strobe	20
TTL Shooting	21-22
Manual Shooting (with pre-flash)	23
Manual Shooting (without pre-flash)	24
Manual Shooting (without pre-flash) Controlled by Camera	25
Selecting Drive Mode.....	26
Selecting Synchronization.....	27
Attaching Arm	28
Installing Viewfinder	29
Camera Setting.....	30-31
Camera Lens Compatibility Table	32
Maintaining Your Housing for Long-lasting Use	33
Handling.....	33
After Use Maintenance.....	34
Storage	34
Battery	34
Daily Maintenance	35
Overhaul	35
Appendix	36
Optional Accessory (Sold Separately).....	36
Specifications.....	37
Underwater Weight	38
After-Sales Service.....	39

Measures to Prevent Accidental Flooding

The INON X-2 housing is waterproof due to a rubber O-ring enabling underwater use. Therefore O-rings and O-ring contact surfaces must be inspected each time before using the housing to ensure waterproof integrity.

O-ring Inspection Locations

The user serviceable O-rings are “Main O-ring” and “Port O-ring”. Be sure to check condition of each O-ring.

O-ring Inspection

These are the essential factors ensuring waterproof property by O-ring;

- O-ring itself,
- O-ring contact surface
- O-ring groove
- If O-ring is properly installed, and
- Grease

First, ***inspect the O-ring as it is seated in the groove***. If any of the following are evident, there is a high chance that the housing will flood underwater. Be very careful about checking these points:

- If hair, sand, lint or other debris is attached to the O-ring
 - Remove/Wipe-off the debris.
 - Remove O-ring as instructed in “Installing, Removing, Replacing O-ring” (p.5) and wipe-off the debris.
- If the O-ring is cut or cracked
 - The damaged O-ring must be replaced with a new O-ring. Please refer “Installing, Removing, Replacing O-ring” (p.5).
- If the O-ring is twisted
 - The O-ring must be removed and reinstalled uniformly with no twists or other irregularities. Please refer “Installing, Removing, Replacing O-ring” (p.5) for reinstallation.
- If there is a scratch, blemish or other imperfection on the O-ring contact surface
 - The housing must be inspected by an INON service facility. Contact your purchasing dealer for advice.

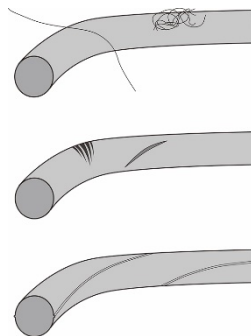

O-ring Maintenance

Periodically re-grease the O-rings only using the supplied INON Grease, to protect O-rings and enhance water resistance. INON yellow O-rings are compounded with a special type of oil which naturally migrates to the O-ring surface, but which is not compatible with all grease types. Do not use any other grease or other oil/fat containing material, which may cause the O-rings to swell or deform, causing poor seal and water leakage. Use of non-INON grease will void warranty.

- For the main O-ring, set the O-ring in place properly and apply a thin film of the supplied grease on the O-ring by a finger.



- The O-rings of the ports are easily damaged by friction, so apply extra grease to both the O-ring (with the O-ring set) and the O-ring contact surface.

Even without any damage, an O-ring itself will deteriorate due to deformation, wear, or changes in the material over time, etc. We recommend periodic overhauls. For details, please refer to "**For Long-Term Use - Overhaul**" (p.21).

Be sure to use the enclosed INON Grease for the yellow O-ring. If you need a new one, please refer to "Reference --- Main Accessories" (p.36).

O-ring Replacement/Removal

O-ring setting condition is very important, especially the main O-ring setting condition significantly changes the waterproof property.

- Your housing has passed factory pressure test with the main O-ring being set as it is. Since an incomplete O-ring set can cause flooding, it is not recommended to remove the main O-ring frequently for regular maintenance.
- If you need to remove the O-ring due to unavoidable reasons (e.g. foreign object attached onto the O-ring or scratched O-ring), please consult your purchasing dealer or follow the instructions below to ensure proper replacement.

- 1 As shown in the right image, pull the O-ring together from both sides, then gently pull it out by pinching the lifted part.



- 2 Make sure that there are no scratches or foreign objects on the O-ring and O-ring groove.
- 3 Take a small amount of INON Grease on your fingertip and spread it evenly on the O-ring. If you need to replace the O-ring, prepare a packaged spare O-ring.
- 4 Install the O-ring into the O-ring groove without stretching or stuffing it without twisting and even out the entire O-ring with your fingers after the installation.
- 5 Check that there are no bumps or kinks throughout the O-ring.
- 6 Proceed to the next section, "Checking Main O-ring Setting Condition".

- An O-ring gives the best sealing performance by adhering evenly to O-ring groove and O-ring contact surface.
- Especially the main O-ring becomes thinner when it is stretched, and thicker when it is filled. In such a situation, the O-ring, O-ring groove, and O-ring contact surface cannot adhere to each other evenly, resulting in a deterioration of waterproof performance.
- Please make sure to follow the instructions in the next section, "Checking the Main O-ring Set Condition". Be especially careful corners, where the thickness can easily become uneven or twisted.

Checking Main O-ring Set Condition

- 1 Clean off the grease from the O-ring contact surface of the rear body, and apply a thin film of grease to the O-ring.



- 2 Close the housing referring to "Closing the housing" (p.10).



- 3 Open the housing to check the O-ring contact surface of the rear body. You should see grease on the O-ring contact surface which indicates the set condition of the O-ring. Broken or uneven width of grease shown in the right is a sign of uneven thickness of the O-ring. See "O-ring Removal/Installation, Replacement" in the previous section and reinstall the O-ring until the width of the transferred grease becomes even.



Please perform O-ring installation carefully and properly, as incomplete installation of O-ring can cause serious flooding.

Name of parts

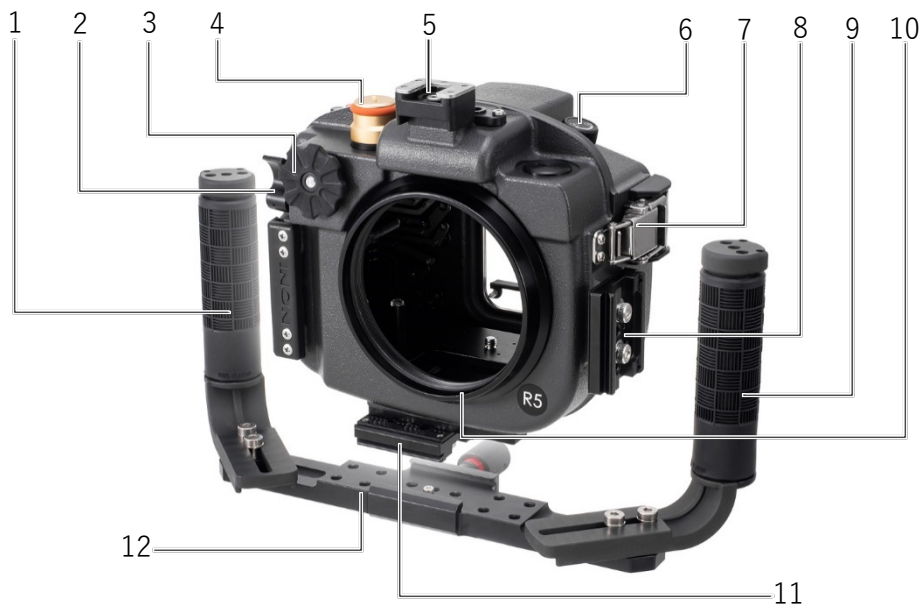

- | | |
|-------------------------|--------------------------|
| 1. D5 Holder | 7. Compression latch |
| 2. Shutter lever | 8. Quick Shoe W50 Plate |
| 3. Quick control dial 1 | 9. D5 Holder |
| 4. Vacuum valve | 10. Port mount |
| 5. Accessory shoe | 11. Quick Shoe W50 Plate |
| 6. Power dial | 12. Quick Shoe Main Base |

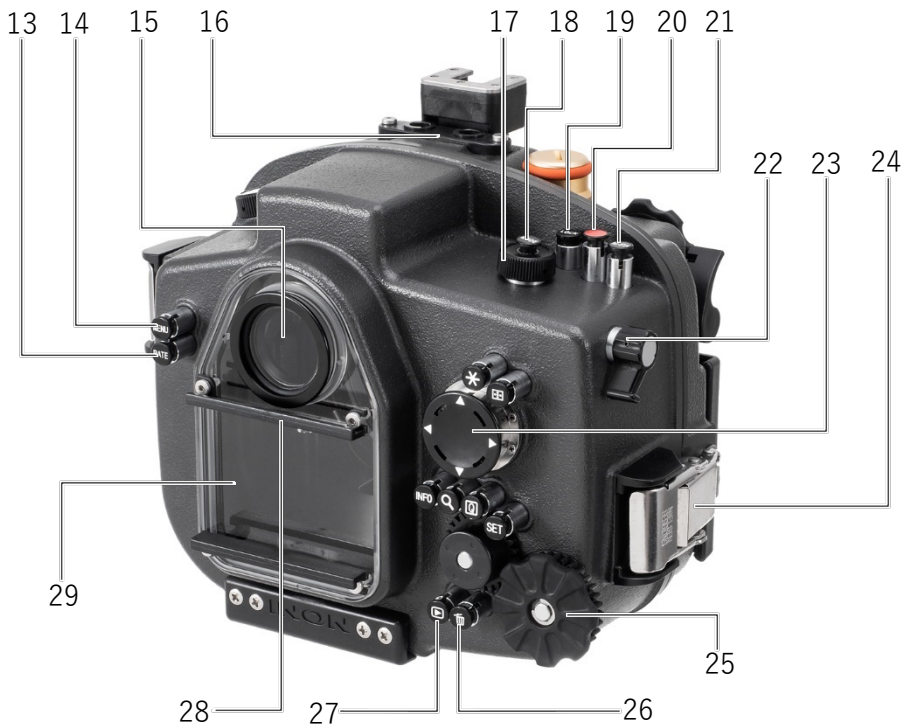

- | | |
|---------------------------------------|-----------------------------------|
| 13. <RATE> Rating/Voice memo button | 22. <AF-ON> AF start button lever |
| 14. <MENU> Menu button | 23. Multi-controller |
| 15. Viewfinder | 24. Compression latch |
| 16. Optical cable adapter | 25. Quick control dial 1 |
| 17. Quick Control Dial 2 | 26. Erase button |
| 18. <MODE> Mode button | 27. Playback button |
| 19. <LOCK> Multi-function lock button | 28. Hood guide rail |
| 20. Movie shooting button | 29. LCD display window |
| 21. <M-Fn> Multi-function button | |

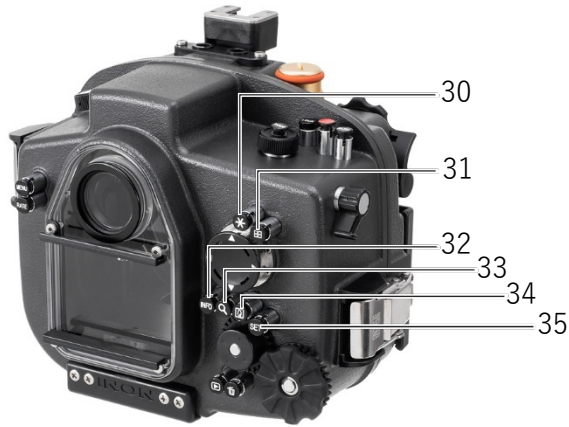

- | | |
|-------------------------------|---------------------------|
| 30. AE lock button | 33. Magnify/Reduce button |
| 31. AF point selection button | 34. Quick control button |
| 32. <INFO> button | 35. <SET> Set button |

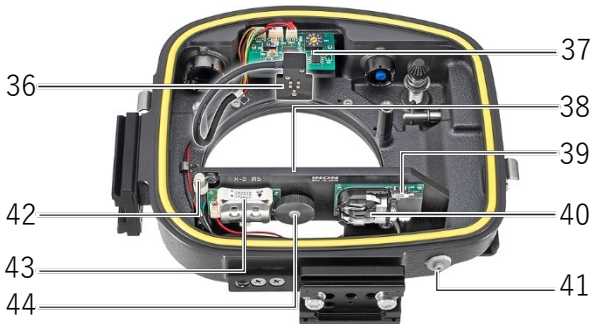

- | | |
|--------------------------------------|---------------------------------|
| 36. Hot shoe connector | 41. Corrosion suppression unit |
| 37. TTL converter unit | 42. Leak sensor LED |
| 38. Camera mount plate | 43. TTL converter battery caddy |
| 39. Vacuum leak sensor switch | 44. Camera fixing screw |
| 40. Vacuum leak sensor battery caddy | |

Usage

Opening the housing

- 1 Open the housing compression latches (left/right) one by one with pushing down lock lever. Hold the rear body not to pop up
- 2 Unhook compression latches from the front body, then lift the rear body straight up. Be sure to place the removed rear body with the O-ring contact surface upward to avoid scratching it.

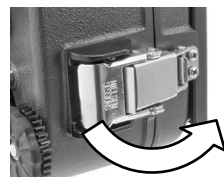

Closing the housing

- 1 Check the main O-ring of the front body and the main O-ring contact surface of the rear body to confirm that there are no scratches or foreign substances on them.

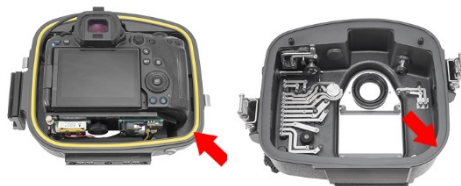

- 2 Hook the compression latches on the front body and pull them up at once. Make sure the latches are securely locked.



- 3 Make sure that there is no gap of more than 0.2 mm between the front and rear bodies. If gap exists, redo the setting.



Quick Shoe Main Base

The "Quick Shoe Main Base" on the bottom of the housing can be detached from the housing.

- 1 Rotate the lock dial of the "Quick Shoe Main Base" counterclockwise until it stops. The lock dial release indicator (red) appears.



- 2 While pushing the housing body toward the lock dial, pull it upward.

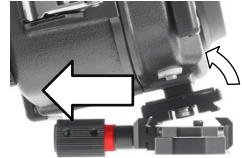

- 3 Reverse the above procedure to attach the "Quick Shoe Main Base" to the housing.

Make sure the lock dial of the "Quick shoe Main Base" shows red, and push the housing body diagonally into the lock dial side of the "Quick Shoe Main Base". After installation, be sure to turn the lock dial clockwise firmly until it stops with green indication.

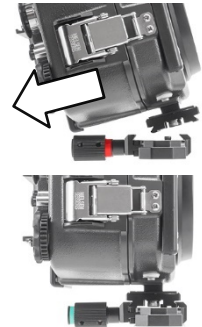

- 4 The housing is equipped with a "Quick Shoe W50 Plate" on the bottom and left side to freely switch between horizontal and vertical shooting positions.



D5 Holder Adjustment

The angle and position of the "D5 Holder" handle on either side of the housing can be adjusted.

- Adjustment of angle
Remove the screws and washers attaching the "D5 Holder" using the supplied "Allen Wrench 4mm".



Choose the angle from 0°, 45°, or 90° and fix the "D5 Holder" again with the screws and washers.



- Adjust position.
The "D5 Holder" has a 40mm width slot. Use the supplied Allen Wrench (4mm) to loosen the screws to adjust the position of the "D5 Holder" as you like.



Installing Port/EXT. Ring

- 1 Check the port O-ring and O-ring groove carefully. Apply extra grease to the O-ring after confirming that the O-ring has no abnormalities.



- 2 Check the O-ring contact surface on the housing carefully. Apply grease after confirming there is no abnormalities.



- 3 Install the port in the housing by turning it clockwise slowly. Turning too fast may damage the O-ring. Be careful not to over-tighten as the port cannot be removed if over-tightened.



Load Battery

The housing requires three CR2032 lithium batteries. Load two into the TTL Converter Battery caddy on the back of the camera stay and one into the Vacuum Leak Sensor Battery caddy.

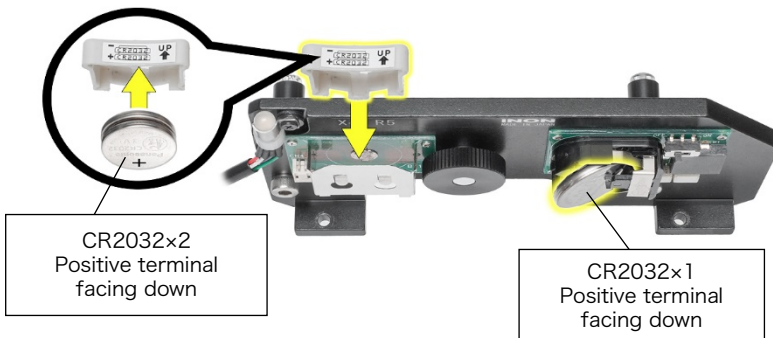

Setting Camera

- 1 Slide the camera over the camera stay and push it in until you hear a clicking sound where the camera mounting screw goes into the camera tripod screw hole.



- 2 Screw the camera fixing screw clockwise into the tripod screw hole of the camera to secure the camera.



- 3 Insert the hot shoe connector firmly into the hot shoe of the camera body all the way to the back.



- 4 Refer to "[Closing the Housing](#)" (p.10) to close the housing and check if all buttons and levers work properly. On land, the "Quick Control Dial 2" should be turned while lightly pressing it.

Vacuum Leak Sensor

The X-2 housing is equipped with a leak sensor that ensures housing sealing before diving and warns you with red LED and buzzer in case of accidental flooding during dive.

1. Power ON

Slide the "Vacuum leak sensor switch" on the camera stay to the right.

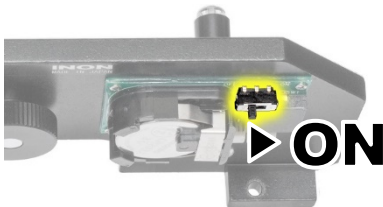

2. Check housing sealing by depressurize the housing

With the camera installed in the housing, remove the gold valve cap and start pumping by a hand pump.



3. LED patterns and meanings

When starting pumping, the LED starts to blink in different colors.

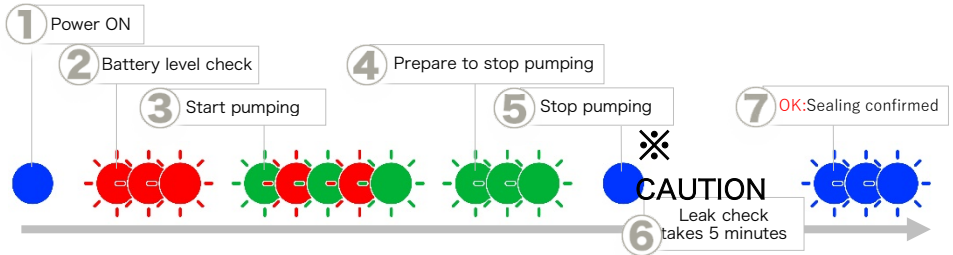

① Power ON

When the "Vacuum Leak Sensor" is turned on, the LED lights up blue for about one second with a beep.

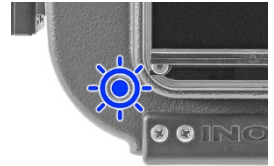

② Battery level

The red blinking patterns indicate battery level.



3 blinks Sufficient



2 blinks Battery level gets low



1 blink Replace the battery

③ Start pumping

The LED blinks alternately red-green-red.



④ Prepare to stop pumping

When the LED blinks green only with single beep, it is about to stop pumping. Slowly and carefully pump.



⑤ Stop pumping

Stop pumping when the LED turns steady blue with double beeps.



※CAUTION

Be sure to put the valve cap back on at this time. Without the valve cap, the leak check will fail.

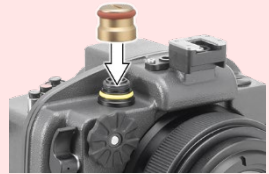

If you continue pumping after the LED turns blue, the LED turns red indicating failure of depressurization.

If this should happen, pull the blue valve upward to restore the pressure in the housing. Open the housing, power off the vacuum leak sensor and start over from procedure ①





⑥ Monitoring sealing condition

After the LED turns blue, the buzzer sounds 30 seconds later, and then the leak check is performed for 5 minutes.



⑦ Check complete

Slow blue blink after 5 minutes is an OK signal and ready to submerge.

	Blue blink	[OK] Proper sealing is confirmed
	Red light with beep	[Failed] Check the condition of the O-ring and start over from step (1).

Be sure to put the valve cap on before entry. Taking the housing underwater without the valve cap will flood the housing.

4. During diving

The vacuum leak sensor functions as a leak detector. In the event of flooding, the sensor on the bottom of the housing detects water droplets, and warns you with a buzzer sound and flashing red LED.



5. Post diving

The housing won't be opened as it due to negative pressure inside. After drying the housing, open the valve cap and pull the blue tab upward to intake air making inner pressure equal to ambient pressure. Now you can open the housing.



When not using the housing for an extended period of time, power off the vacuum leak sensor.

Connecting Optical Cable

A trigger signal of strobe is transferred through an optical cable. Plug compatible cable into the optical cable adapter. Maximum two cables can be plugged by using INON Rubber Bush.

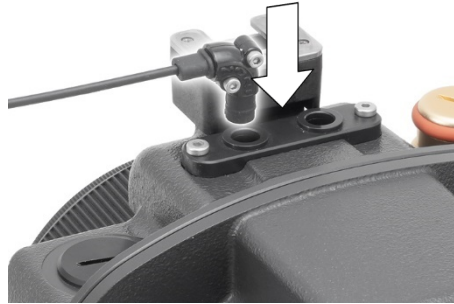

It is recommended to use "Single Hole Rubber Bush Type L". Though maximum four cables can be plugged by using the "Double Hole Rubber Bush Type L", accuracy of TTL may be degraded due to slight misalignment between the center of the light emitting part of the TTL converter inside the housing and the center of the optical cable.

Compatible cable	Optical D Cable Type L Rubber Bush Set 2
	Optical D Cable <u>L</u> Type L Rubber Bush Set 2
	Optical D Cable <u>LL</u> Type L Rubber Bush Set 2
	Optical D Cable <u>SS</u> Type L Rubber Bush Set 2

Compatible strobe	Z-330, Z-240 series
	D-200, D-2000 series
	S-2000

Using Strobe

First, disable “AF-assist beam firing” as the function is not supported by INON strobe.



You can manipulate INON strobe by combination of camera’s [External Speedlite control] and strobe’s “Advanced Cancel Circuitry” settings.

X-sync speed

When a camera is set in the housing, the camera always recognizes that a powered-on strobe is connected to the camera limiting X sync speed at 1/250 or less. This is because the TTL converter starts interactive communication with the camera, once the hot shoe connector is plugged into the camera's hot shoe.



If you are not using a strobe or shooting with only ambient light, enter [External Speedlite control] menu on the camera and disable [Flash firing].

A screenshot of the 'External Speedlite control' menu. The 'Flash firing' option is set to 'Enable' (highlighted in blue).	Using INON strobe
A screenshot of the 'External Speedlite control' menu. The 'Flash firing' option is set to 'Disable' (highlighted in blue).	Not using INON strobe

TTL Shooting

To use INON strobe in TTL auto mode, set camera's [Flash function settings] to [ETTL], and set INON strobe with Advanced Cancel Switch [UP]*, Main Mode Switch [S-TTL] and EV. Control Dial [B].

* Setting without magnet for D-2000 and S-2000 strobe.

■ Camera setting

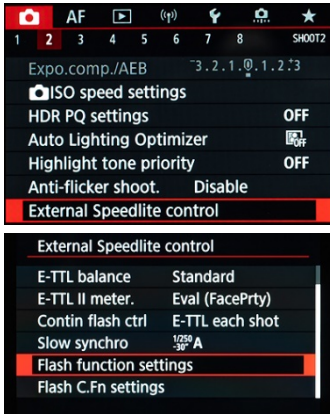

Camera menu screenshot showing 'Flash function settings' set to 'ETTL'. Other settings include: External Speedlite control, E-TTL balance Standard, E-TTL II meter Eval (FacePrty), Contin flash ctrl E-TTL each shot, Slow synchro 1/250 3P-A.

Flash function settings

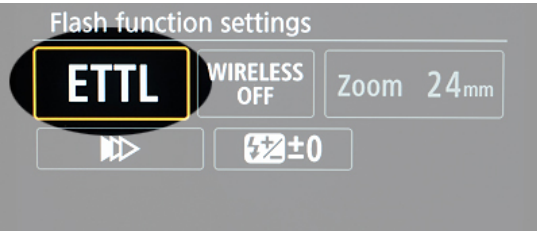

Flash function settings screen showing 'ETTL', 'WIRELESS OFF', and 'Zoom 24mm'. Buttons for 'Next' and 'Reset' are visible.

■ Strobe setting



Strobe control panel showing 'UP' button and 'Super S-TTL EV (+/-) Controller' dial.

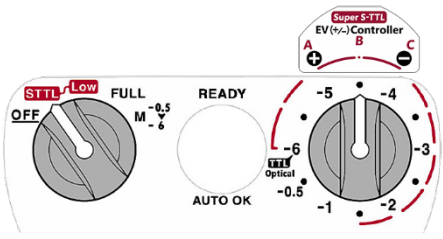

Close-up of the 'Super S-TTL EV (+/-) Controller' dial. The dial has markings for 'STTL Low', 'FULL', 'READY', and 'AUTO OK'. The dial is set to 'Low'.

Strobe output can be adjusted by [Exposure compensation] on the camera. Follow either of below to adjust the strobe output.

- a) [Flash function settings]

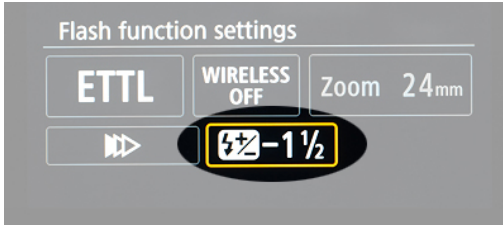

- b) Press the <M-Fn> multi-function button on the housing and rotate the main dial to compensate.

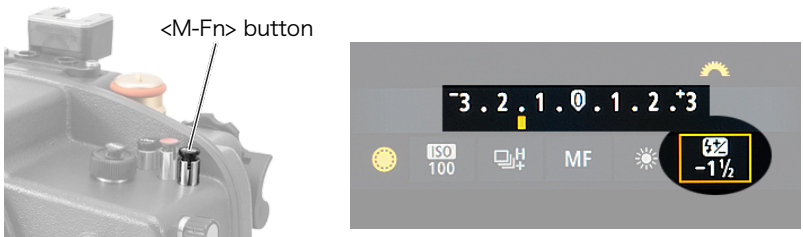

Also, you can select preferable [E-TTL balance] and [E-TTL II meter] in the [External Speedlite control] menu of the camera.

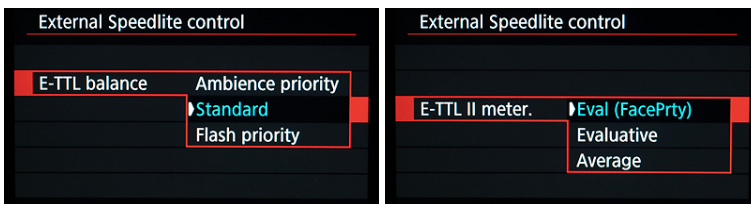

TTL may not work well and cause faint flash when ambient light is very strong. In this case, E-TTL balance [Flash priority] is recommended.

Shooting Manual (with pre-flash)

To use INON strobe in Manual flash mode (with pre-flash), set [E-TTLII] on the camera and set the INON strobe with Advanced Cancel Switch being [UP] (*), Main Mode Switch [FULL] or [M-0.5 ▶ -6]. Select desired power on the EV Control Dial.

(*) D-2000 and S-2000 strobes, [without magnet].

■ Camera setting

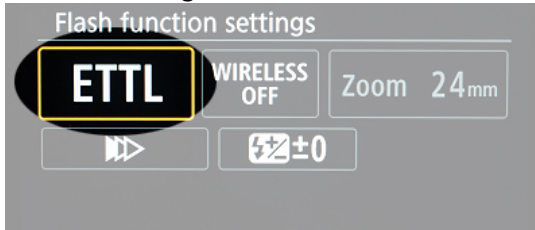

■ Strobe setting

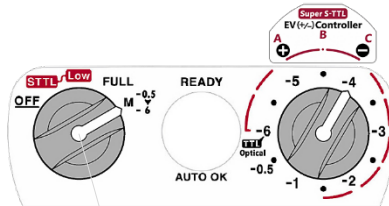

Set [FULL] for full dump
Set [M-0.5 ▶ -6] other than full

Since the pre-flash is a very weak preliminary flash before the main flash, a light sensitive subject may move away.

If you need shooting manual without pre-flash, refer to "**Shooting Manual (without pre-flash)**" on the next page.

Shooting Manual (without pre-flash)

To use INON strobe in Manual flash mode (without pre-flash), set [E-TTLII] on the camera and set the INON strobe with Advanced Cancel Switch being [Push/Lock] (*), Main Mode Switch [FULL] or [M-0.5 ▶ -6]. Select desired power on the EV Control Dial.

(*) D-2000 and S-2000 strobes, [put the magnet in].

Camera setting

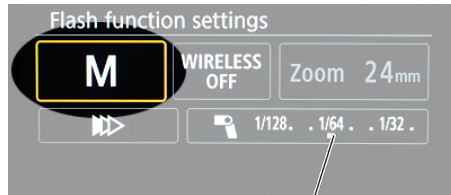
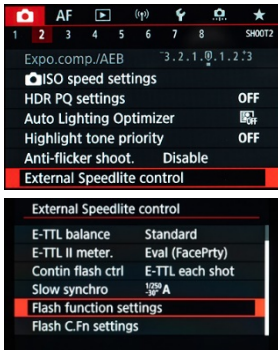

It is recommended to set to "1/64" to reduce battery consumption of the TTL converter.

Strobe setting

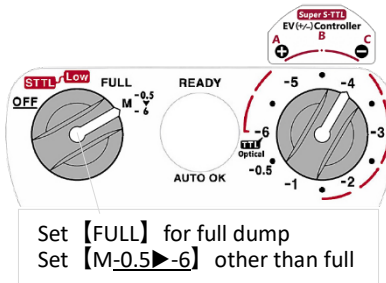

Set **[FULL]** for full dump
Set **[M-0.5 ▶ -6]** other than full

Manual Shooting (without pre-flash) Controlled by Camera

Manual flash output can be controlled directly on the camera.

Set **[M]** on the camera and set the **INON** strobe with Advanced Cancel Switch being **[Push/Lock] (*)**, Main Mode Switch **[FULL]** or **[M-0.5 ▶ -6]**, EV Control Dial **[B]**

(*) D-2000 and S-2000 strobes, [put the magnet in].

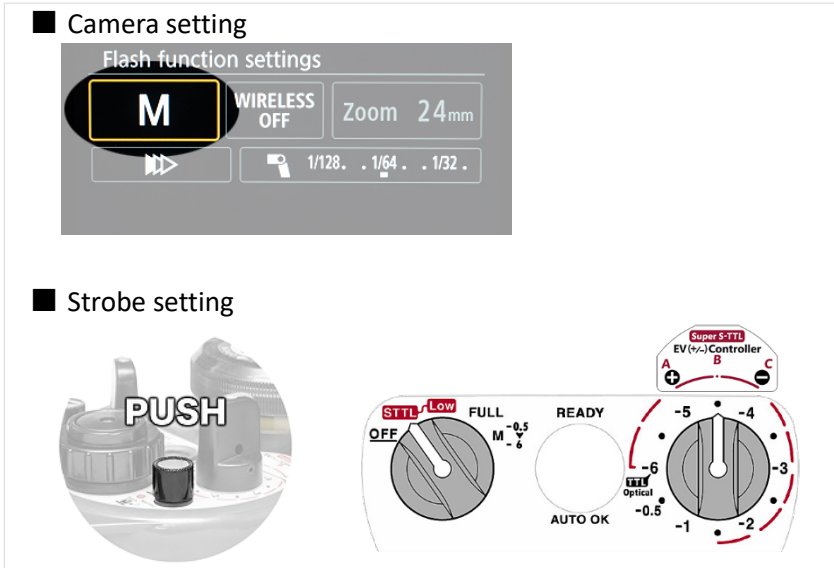



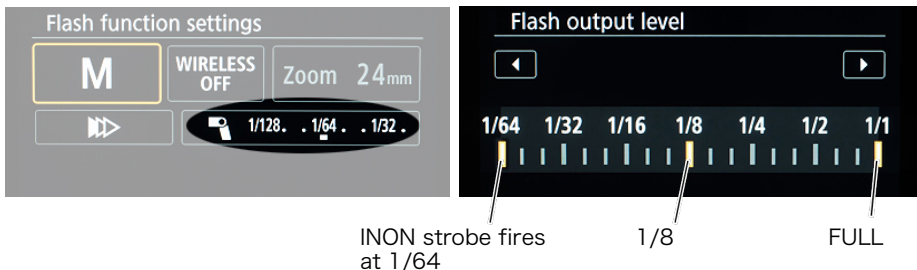

Manual flash output of the INON strobe is synchronized with the [Flash output level] set at [Flash function settings] in the camera menu. Total 19 power settings with 1/3 EV increments.



Selecting Drive Mode

The TTL converter works with various drive modes below supporting both TTL/Manual. Continuous shooting is supported depending on capacitor level (*).

	Single shooting	Fully depressed shutter button gives one shot
	Low-speed continuous shooting	Approx. 1 to 2 shots/sec. continuous shots
	High-speed continuous shooting	Approx. 3 to 4 shots/sec. continuous shots
	High-speed continuous shooting +	Approx. 12.0 shots/sec. continuous shots

(*) The strobe will fire continuously only when the capacitor carries sufficient electricity. Continuous shooting is not supported when setting to FULL as the capacitor drains all electricity for the first dump.

For successful high-speed continuous shooting + (12 frames per second), take the following measures.

- Shooting with TTL Auto
- Locate strobe close to a subject
- Set a high ISO
- Open the aperture (small f number)

Pause the strobe for a few minutes when taking more than 100 consecutive shots to avoid possible damage.

Selecting Synchronization Mode

You can change the camera's sync settings.

Select the sync setting from the camera menu [External Speedlite control] ► [Flash function setting].

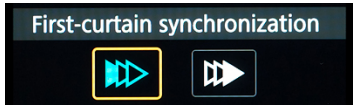
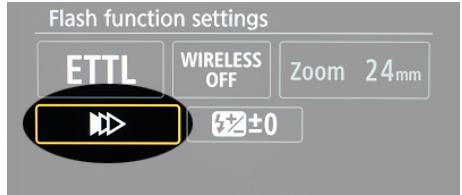
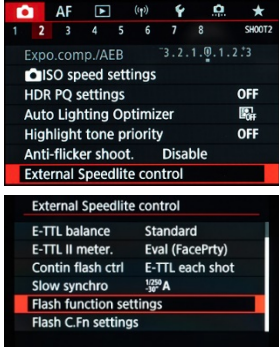

The strobe fires right after the shutter opens. Normally use this mode.

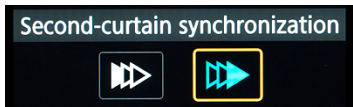

The strobe fires when the shutter closes. This allows capturing the trajectory of the subject naturally at slow shutter speeds.

When using INON strobe in manual flash mode with rear curtain sync Set [M] on the camera and set the INON strobe with Advanced Cancel Switch being [Push/Lock] (p.24).

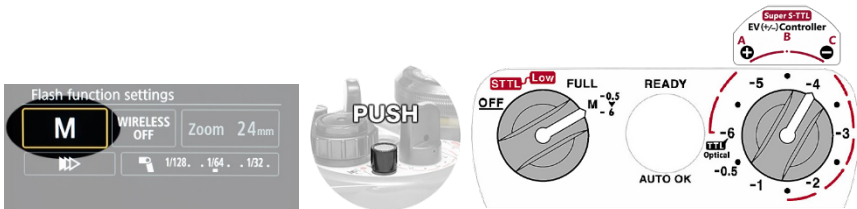

Setting the strobe to "manual shooting (with pre-flash)" will result in synchronization failure when the shutter speed is slower than 1/8.

Installing Arm System

A variety of arm products are available to suit your strobe and shooting style.

Optional "Direct Base III" allows you to attach the supplied "D5 Lanyard Plate" on "D5 Holder" in eight different orientations.



In addition to the "Direct Base III", a variety of other adapters can be installed.



The accessory shoe on the top of the housing is designed to hold below optional adapter.

- Shoe Base II
- Shoe Base 1/4-20UNC
- Shoe Base M6
- Shoe Base BALL



Installing Viewfinder

Optional "Straight Viewfinder Unit II for X-2" or "45° Viewfinder Unit III for X-2" can be installed.

- 1 Remove the upper "hood rail" on the housing rear body with the supplied Allen wrench

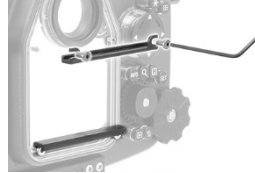

- 2 Use the optional "Lock Ring Tool for X-2 Finder Unit" to remove the "Lock Ring for Viewfinder Unit" from the back side of the housing rear body.

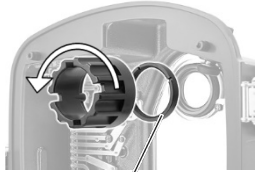

Lock Ring for Viewfinder Unit

- 3 Pull out the preinstalled "Finder Window Unit" from the housing, then align the two pins on the base of the viewfinder unit with the pin holes on the rear panel of the housing and push it in.

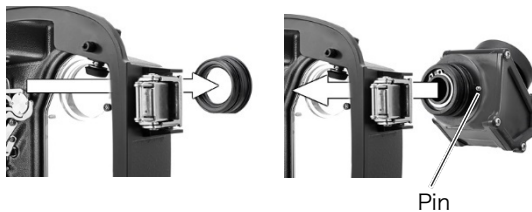

- 4 After pushing in the viewfinder unit, tighten the "Lock Ring for Viewfinder Unit" using the "Lock Ring Tool for X-2 Finder Unit" in the reverse order of removal.



- 5 Refer to [Leak Sensor](#) (p.15) and conduct leak check to ensure housing sealing

Camera Setting

The following are the recommended settings for the Canon EOS R5 when using the X-2 R5 housing.

1 Switching between viewfinder and screen

First, disable the eye sensor: [Screen/viewfinder display] ► [Screen].

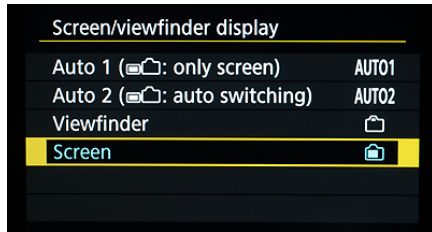

Next, assign [Switch between VF/screen] to the [AE Lock button]

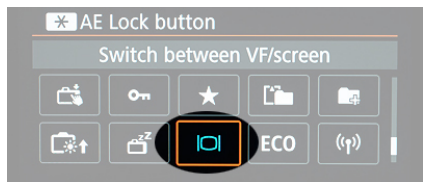
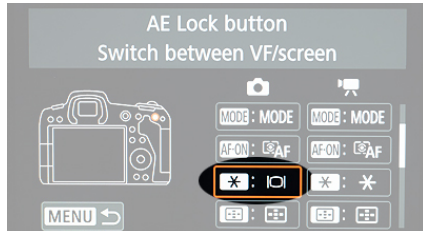
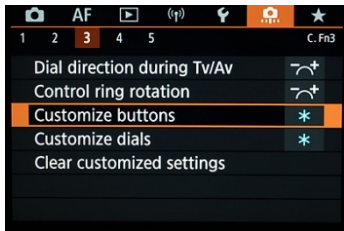

Press the [AE lock button] to switch between viewfinder and screen.

2 [Flash function setting]

Assign flash function setting to the Movie shooting button.

[Customize buttons] ► [Movie shooting button] ► [Flash function setting]

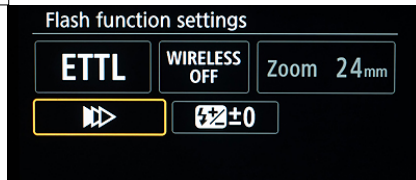
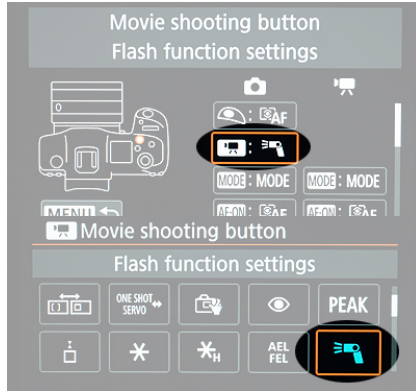
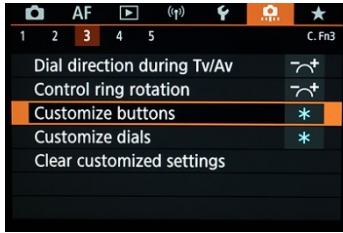

This customization allows you to recall frequently used [Flash function settings] quickly.

Lens Compatibility

Fisheye lens	Port/EXT. Ring	Magnet Ring
Canon EF8-15mm F4L Fisheye USM Mount Adapter EF-EOS R	M86 Dome Port 115 MRS EXT. Ring 33 EXT. Ring 18	Magnet Ring S-MRS Magnet Ring (*1)
Macro lens	Port/EXT. Ring	Magnet Ring
Canon RF35mm F1.8 MACRO IS STM	M86 Dome Port 115 MRS EXT. Ring 33 M86 Port 17 (*2) MRS EXT. Ring 33	S-MRS Magnet Ring RF35 Set (*3)
SIGMA 70mm F2.8 DG MACRO Mount Adapter EF-EOS R	M86 Port 82 MRS EXT. Ring 33 EXT. Ring 36	S-MRS Magnet Ring S70 Set
Canon RF85mm F2 MACRO IS STM	M86 Port 55 MRS EXT. Ring 33	S-MRS Magnet Ring (*3)
Canon RF100mm F2.8 L MACRO IS USM	M86 Port 07 MRS EXT. Ring 111	S-MRS Magnet Ring (*4)
Canon EF100mm F2.8L Macro IS USM Mount Adapter EF-EOS R	M86 Port 49 MRS EXT. Ring 33 EXT. Ring 36	S-MRS Magnet Ring

(*1) For zooming. Manual focusing is not supported. Auto focus (AF) only.

(*2) Close the aperture when shooting at or nearly minimum focusing distance as open aperture will have deterioration on image corners.

(*3) Manual focusing (MF) only. "Control Ring" operation is not supported.

(*4) Using Control Ring, Focus Ring or SA Control Ring of the "RF100mm F2.8 L MACRO IS USM" underwater requires "S-MRS Magnet Ring". So prepare necessary quantity of S-MRS Magnet Ring depending on how you control those rings.

Lens	Port/EXT. Ring	Magnet Ring
Canon EF8-15mm F4L Fisheye USM Mount Adapter EF-EOS R	Dome Port 115 EXT. Ring 36	None Zooming is not supported
	Dome Port II · Shade II Set EXT. Ring 36	None Zooming is not supported
Canon EF100mm F2.8L Macro IS USM Mount Adapter EF-EOS R	MRS100 Port Type UIII EXT. Ring 18	MRS Magnet Ring
	MRS100 Port Type UII EXT. Ring 36	MRS Magnet Ring

Maintaining Your Housing for Long-lasting Use

Handling

- Avoid vibrations and shocks

The INON X-2 is precisely calibrated and should not be subjected to severe vibration such as boating, dropping, bumping, etc. When carrying the housing, wrap it with a thick towel to avoid vibration or shock. Even without external damage, there may be deformation or loosening of parts which may prevent operation of the camera or may cause flooding accident. Please consult your dealer if you think your housing has got damaged.

- **DO NOT** leave the housing in hot places

Do not leave the housing in places with high temperature, such as in direct sunlight (e.g. on a beach or on a boat deck) or in a heated car. Doing so may not only damage the camera or housing but also cause flooding due to thermal deformation.

- **DO NOT** disassemble

This product is assembled with advanced engineering and should not be disassembled as it may cause malfunction or flooding. Please consult your dealer in case of malfunction or failure. INON Inc cannot compensate for any damage caused by disassembly or modification by the customer.

- **DO NOT** jump in water with your housing

Jumping into the water with housing or strobe may cause unexpected problem due to impact shock on the water surface. When entering from a boat, enter without equipment and have someone hand it to you or put the equipment down with a rope before entering.

- **DO NOT** subject the sealed housing to lower pressure

The housing is designed to withstand external pressure (water pressure) but not internal pressure buildup (decrease in external pressure). Be sure to remove a port when transporting the housing through high altitude or by aircraft.

- **DO NOT** let water get inside

Avoid opening/closing the housing or installing/removing the port in splashing water or humid environment. If you need to open/close the housing in such environment, wash the outside of the housing with fresh water and wipe thoroughly before opening/closing. Preparing the housing in humid place or with moisture on it may cause condensation inside the port or viewfinder due to temperature difference during underwater use.

After Use Maintenance

After using the product in seawater, soak it in fresh water (below room temperature, not hot water) for several hours to remove salt. Slowly move dials, levers and buttons to wash away any remaining sand, salt, etc. Be sure to thoroughly wash the optical adapter window as cloudy window by residual salt can prevent proper signal transmission. Dry the housing thoroughly in shaded and well ventilated area. It may take a few days to completely dry moisture in gaps even the surface is dry. Check O-rings of each part and grease them.

Storage

Store in a dry and well-ventilated place, out of direct sunlight, with the batteries removed and the housing closed. DO NOT store near chemicals (camphor, naphthalene, etc.) or in a place where temperature changes rapidly. It is recommended to put a drying agent in the housing during storage.

Battery

Three "CR2032" lithium batteries are required. When the battery is drained, the "TTL Converter" and/or "vacuum leak sensor" becomes inoperable, so please replace the battery referring to "Load Battery" (p13). The battery life varies depending on usage and other factors.

- TTL Converter Battery Check

Conduct test shot using an external strobe in TTL mode. If the strobe delivers too much light or not in synch, it is time to replace the battery.

- Vacuum Leak Sensor Battery Check

Vacuum Leak Sensor provides battery level check function. Refer to p16 for detail.

Daily Maintenance

- If the shutter release lever, dials, or buttons do not work properly
Operate the lever, dials and buttons in fresh water without camera. If this does not help, please consult your dealer.
- If the zoom/focus operation is not working properly
First, check that the magnet ring is installed on the correct position of the lens, referring to the respective instruction manual, and that manual focus and zoom operations can be performed smoothly with the lens itself. If this problem persists, please consult your purchasing dealer.
- If corrosion suppression unit gets small and rattles,
Retighten the Corrosion Suppression Unit using the supplied 3 mm hex key. If the unit becomes too small to be tightened, replace the corrosion suppression unit by referring to "Appendix --- Accessories" (p37).

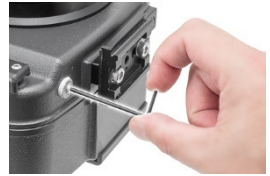

Overhaul

This product is designed and manufactured for use under severe conditions. However, in order to maintain rated performance including waterproof property, it is necessary to perform various inspections before use and maintenance after use. In addition, it is necessary to get the product overhauled periodically to check consumables including O-rings and to check for any problems such as rattling. It is recommended to overhaul annually in order to prevent accidental flooding.

Appendix

Optional Accessory

Optional accessories including optical cables, arms, adapters etc. and maintenance parts.

- Optical D Cable Type L Rubber Bush Set 2
Optical D Cable L Type L Rubber Bush Set 2
Optical D Cable LL Type L Rubber Bush Set 2
Optical D Cable SS Type L Rubber Bush Set 2
- Direct Base III
A ball adapter to connect to the tip of the handles "D5 Holder" allowing you to expand arm system via Clamp III.
- Shoe Base II
Directly attached to the accessory/cold shoe of the housing for various arm configurations.
- Corrosion suppression unit
Replacement unit when the pre-installed corrosion suppression unit wears out. The unit prevents the X-2 housing from rusting by rusting itself.
- X-2 Main O-ring 175
Replacement O-ring for the housing body. Oil-bearing type yellow O-ring.
- X-2 Port/GX EXT. Ring O-ring
Replacement O-ring for port/EXT Ring. Oil-bearing type yellow O-ring.
- M86 Port O-ring
Replacement O-ring for M86 Port. Oil-bearing type yellow O-ring.
- INON Grease
Dedicated grease for oil-bearing type INON yellow O-rings.

Specifications

Compatible camera	Canon EOS R5																						
Compatible strobe	INON Z-330/D-200/S-2000/Z-240/D-2000 series																						
Accessible camera controls	<table border="0"> <tr> <td><MODE> button</td> <td>Magnify/Reduce button</td> </tr> <tr> <td>Movie shooting button</td> <td>Quick Control button</td> </tr> <tr> <td>Main dial</td> <td><INFO> Info button</td> </tr> <tr> <td><M-Fn> Multi-function button</td> <td><SET> Set button</td> </tr> <tr> <td>Shutter button</td> <td>Erase button</td> </tr> <tr> <td>Power switch</td> <td>Playback button</td> </tr> <tr> <td><MENU> Menu button</td> <td><RATE> Rating/Voice memo button</td> </tr> <tr> <td><LOCK> Multi-function lock button</td> <td>AE lock button</td> </tr> <tr> <td>Quick control dial 2</td> <td>AF point selection button</td> </tr> <tr> <td><AF-ON> AF start button</td> <td>Quick control dial 1</td> </tr> <tr> <td>Multi-controller</td> <td></td> </tr> </table>	<MODE> button	Magnify/Reduce button	Movie shooting button	Quick Control button	Main dial	<INFO> Info button	<M-Fn> Multi-function button	<SET> Set button	Shutter button	Erase button	Power switch	Playback button	<MENU> Menu button	<RATE> Rating/Voice memo button	<LOCK> Multi-function lock button	AE lock button	Quick control dial 2	AF point selection button	<AF-ON> AF start button	Quick control dial 1	Multi-controller	
<MODE> button	Magnify/Reduce button																						
Movie shooting button	Quick Control button																						
Main dial	<INFO> Info button																						
<M-Fn> Multi-function button	<SET> Set button																						
Shutter button	Erase button																						
Power switch	Playback button																						
<MENU> Menu button	<RATE> Rating/Voice memo button																						
<LOCK> Multi-function lock button	AE lock button																						
Quick control dial 2	AF point selection button																						
<AF-ON> AF start button	Quick control dial 1																						
Multi-controller																							
Lens control	Operable by S-MRS system																						
Optical cable connector	Two																						
TTL Converter	Ver. R5 Operated by two CR2032 batteries																						
Leak Sensor (buzzer/LED)	Built-in battery level/function check switch Operated by one CR2032																						
Size	W208 x H192 x D123mm/W8.2 x H7.6 x D4.8 inch (housing body only) W365 x H208 x D123mm/W14.4 x H8.2 x D4.8 inch (incl. base tray and handles)																						
Weight (air)	1,777g/3.9 lbs (housing body only) 2,344g/5.2 lbs (incl. base tray and handles)																						
Depth rating	75m/246ft																						
Operating temperature	0°C~+40°C/32°F-104°F																						
Material	Corrosion-resistant aluminum alloy																						
Color	Teflon-molybdenum coating: charcoal gray																						
Accessory	Vacuum pump, INON Grease																						

Underwater Weight

Fisheye lens	Port/EXT. Ring	Magnet Ring	U/W Weight 1	U/W Weight 2
Canon EF8-15mm F4L Fisheye USM Mount Adapter EF-EOS R	M86 Dome Port 115 MRS EXT. Ring 33 EXT. Ring 18	S-MRS Magnet Ring	840 g/29.4 oz	520 g/18.3 oz

Macro lens	Port/EXT. Ring	Magnet Ring	U/W Weight 1	U/W Weight 2
Canon RF35mm F1.8 MACRO IS STM	M86 Dome Port 115 MRS EXT. Ring 33	S-MRS Magnet Ring RF35 Set	545 g/19.2 oz	225 g/7.9 oz
	M86 Port 17 (*2) MRS EXT. Ring 33		541 g/19.1 oz	221 g/7.8 oz
Canon RF85mm F2 MACRO IS STM	M86 Port 55 MRS EXT. Ring 33	S-MRS Magnet Ring	520 g/18.3 oz	200 g/7.1 oz
Canon RF100mm F2.8 L MACRO IS USM	M86 Port 07 MRS EXT. Ring 111	S-MRS Magnet Ring	585 g/20.6 oz	265 g/9.3 oz
Canon EF100mm F2.8L Macro IS USM Mount Adapter EF-EOS R	M86 Port 49 MRS EXT. Ring 33 EXT. Ring 36	S-MRS Magnet Ring	650 g/22.9 oz	330 g/11.6 oz

Add 129 g/4.6 oz when Straight Viewfinder Unit II is installed.
Add 153 g/5.4 oz when 45°Viewfinder Unit III is installed.

Underwater weight is measured in fresh water (density = 1).

Actual measurement with camera/lens/battery/recording media in housing. Actual weight may vary depending on individual product and measurement conditions.

After-sales Services

- Product inquiry

Contact your purchasing dealer or INON INC. for inquiry regarding your housing.

- Request for inspection and repair

Please contact your purchasing dealer. If you are unable to have the product inspected or repaired by your dealer, please contact us.

- Product Warranty

The product warranty is provided by a dealer/distributor. Warranty repair will be conducted under the conditions.

- Manufacture

INON INC.

2-18-9 Dai, Kamakura

Kanagawa 247-0061

Japan

E-mail support@inon.co.jp

Fax. +81(0) 467-48-2178

URL <http://www.inon.jp/>

Version

• November 2021 Ver.1.0.0